

PPC-6151C

15" Configurable Panel PC Chassis for Selectable Mini-ITX Motherboards



Features

- 15" true-flat panel PC with resistive touch
- Supports certified mini-ITX motherboards (up to 65W TDP processor)
- PCI or PCIe expansion slots
- Front-facing power status LED indicators
- IP66-rated front panel

Vertrieb durch



AMC – Analytik & Messtechnik GmbH Chemnitz

Heinrich-Lorenz-Str. 55 Tel.: +49/371/38388-0
 09120 Chemnitz Fax: +49/371/38388-99
 E-Mail: info@amc-systeme.de Web: www.amc-systeme.de



Specifications

Model	PPC-6151C-RTAE	PPC-6151C-RMAE
Supported Motherboard	PPC-MB series	AIMB-275
Chassis	Storage	1 x 2.5" SATA HDD bay /2 x 2.5" SATA HDD bay (optional)
	I/O	4 x Reserved ports (DB9) 2 x WLAN antenna holes
		1 x AC inlet 1 x Power switch Reserved opening: According to the PPC-MB series motherboard specifications
	Expansion	1 x PCIe x4 or 2 x PCI (in the accessory box), 2 x PCIe x1 (optional), 1 x PCIe x1 + 1 x PCI (optional) 2 x PCIe x8 (optional, only for PPC-MB-6x0) 1 x PCIe x16 (optional, only for PPC-MB-6x0)
	Speaker	2 x 1 W
Physical Characteristics	Fan	2 x 12V; 60 x 60 x 15 mm (2.36 x 2.36 x 0.59 in)
	Dimensions (W x H x D)	391.4 x 312.5 x 103.6 mm (15.4 x 12.3 x 4.08 in)
	Weight	5.03 kg (11.08 lb)
OS Support	OS Support	According to motherboard specifications
Power Consumption	Input Voltage	100 ~ 240 V _{AC} , 250W
	Power Consumption	SKL: 90W/KBL:120W (with PPC-MB-8260AE) CFL: 162W (with PPC-MB-610)
LCD	Display Type	15" TFT LED panel
	Max. Resolution	1024 x 768
	Viewing Angle	88 (left), 88 (right), 88 (up), 88 (down)
	Luminance (cd/m ²)	500
	Contrast Ratio	2500
	Backlight Lifetime	50,000 hr
Touchscreen	Touch Type	5-wire analog resistive, with optional projected capacitive touch
	Light Transmission	80+/-5%
	Controller	USB interface
	Durability	35 million touches
Environment	Operating Temperature	0 ~ 50 °C (32 ~ 122 °F)(With 35W CPU)
		0 ~ 45 °C (32 ~ 113 °F)(With 65W CPU)
		*** please refer to the PPC-MB series CPU list
	Storage Temperature	-30 ~ 60 °C (-22 ~ 140 °F)
	Relative Humidity	10 ~ 95% @ 40 °C (non-condensing)
	Shock	Operating: 10 G peak acceleration (11 ms duration), IEC 60068-2-27 compliant
	Vibration	Operating: Random vibration test 5 ~ 500 Hz, 1 Grms @ with HDD, IEC 60068-2-64 compliant
	EMC	CE,FCC,Class A,UKCA,VCCI
Safety	CB,CCC,UL,UKCA	
Front Panel Protection	IP66 compliant	



ADVANTECH Automation
Premier Partner

Dimensions

Unit: mm

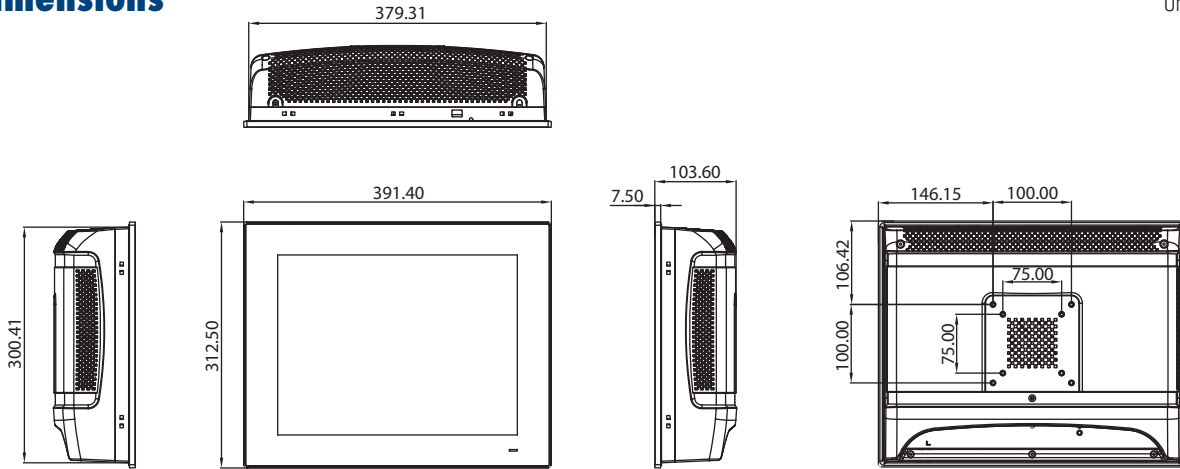

Panel Cutout Dimensions: 382 x 303 mm (15.03 x 11.92 in)

Ordering Information

M/B Part Number	Chassis Part Number	Cooler Part Number
PPC-MB-8260B / PPC-MB-610B (assembled in China)	PPC-6151C-RTAE (assembled in China)	1960053207N001
PPC-MB-8260BU/ PPC-MB-610BU (assembled in Taiwan)	PPC-6151C-RTAU (assembled in Taiwan)	1960053207N001
AIMB-275	PPC-6151C-RMAE	1960053207N001

Note 1. The motherboard, chassis, and cooler should be ordered together to ensure easy configuration.
 Note 2. The chassis is equipped with AC power supply and riser cards.

Optional Accessories

Part Number	Description
PPC-WLAN-D1	M.2, WiFi6 +BT5.2, 2T2R, w/Antenna, Mini PCIe adapter
1702002605	Power cable (EU) 90D 220 ~ 250V/6A, 1.8 M
1702002600	Power cable (US) 180D 125V/10A, 1.83 M
1702031801	Power cable (UK), 1.8 M
96CB-POWER-B-1.8MA	Power cable (China), 1.8 M
9893BE0200E	Riser card with 2 x PCIe x1 slots
9893BE03000	Riser card with 1 x PCIe x1 and 1 x PCI slots
9893BE17000	Riser card with 2 x PCIe x8 slots (only for PPC-MB-6x0)
98R36151C20	Riser card with 1 x PCIe x16 slots (only for PPC-MB-6x0)
PPC-ARM-A03	ARM VESA Standard for PPC series
PPC-174T-WL-MTE	Wall mount kit for PPC series
PPC-Stand-A1E	Stand for PPC series
1700027838-01	Cable for two internal USB for PPC-MB-XXXX with I/O BKT
98R36151C10	the second 2.5"SATA HDD (only one riser card slots available)
98R3P612100	TPM2.0 module for PPC-MB-610

I/O View

PPC-6151C-RTAE

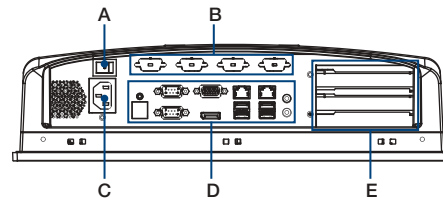

- A. Power switch
- B. Reserved ports
- C. AC inlet
- D. PPC-MB-XXXX I/O port
- E. Expansion x 2

Note 1: The max. dimension of expansion cards supported is 178 x 107 x 40 mm.
 Note 2: If the two slots are to be used simultaneously, the max. dimension supported is 178 x 107 x 20 mm for each PCI or PCIe expansion card.
 Note 3: The max. power consumption of PCIe expansion card supported is 75W.
 Note 4: If use dual HDD kits, only one riser card slots available.

PPC-6151C-RMAE

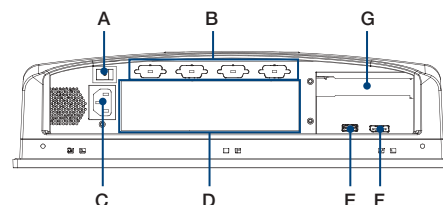

- A. Power switch
- B. Reserved ports
- C. AC inlet
- D. Mini-ITX motherboard I/O port
- E. USB 2.0 (input, for connecting the motherboard and touch controller)
- F. Display port (input, for connecting the motherboard and LVDS panel)
- G. Expansion x 1

Please note: If some optional modules are offered with the system, additional system certificates may be required in certain regions/countries.
 Please contact Advantech for certificate compliance.

M/B offering for PPC-61X1C-RTAE

PPC-MB-8260xx

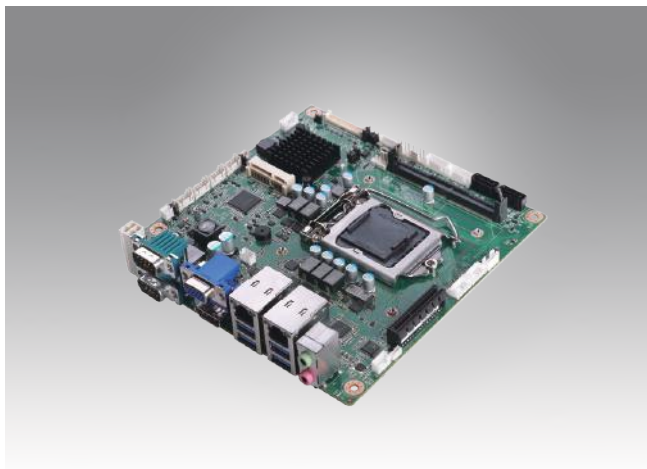

Features

- Supports Intel® 6th & 7th Gen Core™ i processor (LGA1151) with Intel H110 chipset
- One 260-pin SO-DIMM up to 16GB DDR4 2133 MHz SDRAM
- Supports Dual display of DP/VGA/LVDS
- Supports 1 F/S miniPCIe or mSATA, 4 USB 3.0 and 2 USB 2.0
- Supports 1 PCIe x4(Gen3)
- Supports 2 SATA 6 Gb/s Ports
- Supports 4 RS-232, 1 RS-232/422/485
- Supports 1 GPIO(8 channels)

Specifications

CPU	CPU	KBL	i7-7700	i5-7500	i3-7101E	/	/
		SKL	i7-6700TE	i5-6500TE	i3-6100TE	Pentium G4400TE	Celeron G3900TE
	Core NO.	Quad Core		Quad Core	Dual Core	Dual Core	Dual Core
		MAX Speed	KBL	3.6GHz (up to 4.2GHz)	3.4GHz (up to 3.8GHz)	3.9GHz	/
	SKL	2.4GHz (up to 3.4GHz)	2.3GHz (up to 3.3GHz)	2.7GHz	2.4GHz	2.3GHz	
	L3 Cache	KBL	8M	6M	4M	/	/
SKL				3M	3M	2M	
TDP	KBL	65W	65W	54W	/	/	
	SKL	35W	35W	35W	35W	35W	
Chipset		H110					
Memory		1 x 260-pin SODIMM DDR4, 2133 MHz, up to 16 GB (non-ECC)					
Network (LAN)		2 x 10/100/1000 Mbps Ethernet (Intel I211-AT/I210AT A ver. or Realtek 8119i B ver.)					
Rear I/O		1 x RS232/422/485, 1 x RS232, 1 x DP1.2, 1 x VGA, 4 x USB3.0, 1 x Line-out, 1 x Mic-in					
Internal Connector		3 x RS232, 1 x GPIO (8 channels), 1 x speaker, 1 x LED, 2 x USB 2.0, 1 x LVDS, 1 x touch control, 2 x SATA					
Watchdog Timer		255 timer intervals, configurable using software					
Expansion		1 x full-size mSATA or mini PCIe and 1 x PCIe x4 slot for riser card					
Dimensions (W x H)		170 x 170 mm (6.69 x 6.69")					
OS Support		Microsoft® Windows 7 (32/64-bit), Windows 8.1, Windows 10 IOT LTSC(64-bit), (**KBL CPU only support windows 10 64bit)					

Ordering Information

Part Number	Description
PPC-MB-8260B	6/7th core i M/B, H110, assembled in China
PPC-MB-8260BU	6/7th core i M/B, H110, assembled in Taiwan

I/O view

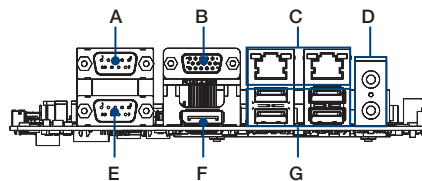

- A. RS232
- B. VGA
- C. 2 x Gigabit Ethernet
- D. Line-out/Mic-in
- E. RS232/422/485
- F. Display Port
- G. USB 3.0

Vertrieb durch



AMC – Analytik & Messtechnik GmbH Chemnitz

Heinrich-Lorenz-Str. 55 Tel.: +49/371/38388-0
 09120 Chemnitz Fax: +49/371/38388-99
 E-Mail: info@amc-systeme.de Web: www.amc-systeme.de



ADVANTECH iAutomation
 Premier Partner

PPC-MB-610x

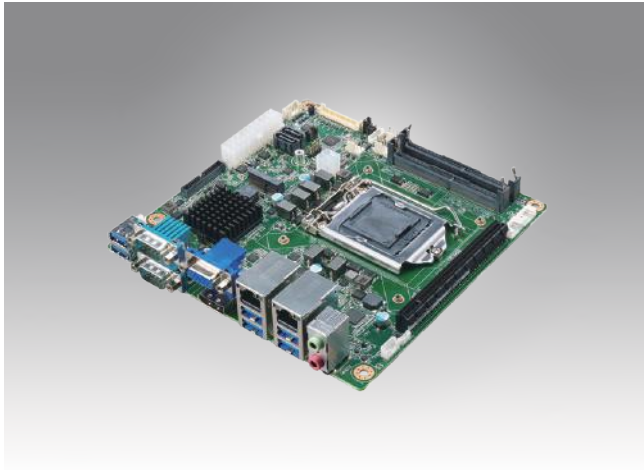

Features

- Supports Intel® 8th & 9th Gen Core™ i processor (LGA1151) with Intel Q370 chipset
- Two 260-pin SO-DIMM up to 32GB DDR4 2666 MHz SDRAM
- Supports triple display of DP/VGA/LVDS
- Supports PCIe x16 (Gen 3), 1 M.2 M key & 1 M.2 E key, 6 x USB 3.1
- Supports 2 x SATA 3.0 (Raid 0, 1)
- Supports TPM 2.0 (optional)
- Supports 4 RS-232, 1 RS-232/422/485
- Supports 1 GPIO(8 channels)

Specifications

	CPU	i7-8700/ i7-8700T	i5-8500/ i5-8500T	i3-8100/ i3-8100T	Pentium G5400/G5400T	Celeron G4900/ G4900T	i7-9700E/ i7-9700TE	i5-9500E/ i5-9500TE	i3-9100E/ i3-9100TE
CPU	Core NO.	6/6	6/6	4/4	2/2	2/2	8/8	6/6	4/4
	Max Speed	3.2 GHz (up to 4.6GHz)/ 2.4 GHz (up to 4.0GHz)	3.0 GHz (up to 4.1GHz)/ 2.1 GHz (up to 3.5GHz)	3.6/3.1 GHz	3.7 / 3.1 GHz	3.1 / 2.9 GHz	2.6GHz (up to 4.4GHz)/ 1.8 GHz (up to 3.8GHz)	3.0GHz (up to 4.2GHz)/ 2.2 GHz (up to 3.6GHz)	3.1GHz (up to 3.7GHz)/ 2.2 GHz (up to 3.2GHz)/
	L3 Cache	12 / 12 MB	9 / 9 MB	6 / 6 MB	4 / 4 MB	2 / 2 MB	12 / 12 MB	9 / 9 MB	6 / 6 MB
	TDP	65 / 35 W	65 / 35 W	65 / 35 W	54 / 35 W	54 / 35 W	65 / 35 W	65 / 35 W	65 / 35 W
Chipset	Q370								
Memory	2 x 260-pin SODIMM DDR4 , 2666 MHz , up to 32 GB (non-ECC)								
Network (LAN)	2 x 10/100/1000 Mbps Ethernet [Intel I219LM (support AMT 12.0 only for i7 & i5); Intel I211-AT/I210AT A ver. or I225LM(2.5GbE) B ver.]								
Rear I/O	1 x RS232/422/485 , 1 x RS232 , 1x DP1.2 , 1 x VGA , 6 x USB3.1 , 1 x Line-out , 1 x Mic-in								
Internal Connector	3 x RS232 , 1 x GPIO (8 channels) , 1 x speaker , 1 x LED , 2 x USB 2.0 , 1 x LVDS , 1 x touch control , 2 x SATA 3.0 (support RAID 0,1) , 1 x TPM2.0								
Watchdog Timer	255 timer intervals , configurable using software								
Expansion	1 x M.2 slot(2280 M key) for storage; 1 x M.2 slot (2230) for wireless 1 x PCIe16 slot for riser card								
Dimensions (W x H)	170 mm x 170 mm (6.69" x 6.69")								
OS Support	Microsoft® Win 10 IOT LTSC(64-bit), Linux								

Ordering Information

Part Number	Description
PPC-MB-610B	8/9th core i M/B, Q370, assembled in China
PPC-MB-610BU	8/9th core i M/B, Q370, assembled in Taiwan

Vertrieb durch



AMC – Analytik & Messtechnik GmbH Chemnitz

Heinrich-Lorenz-Str. 55 Tel.: +49/371/38388-0
 09120 Chemnitz Fax: +49/371/38388-99
 E-Mail: info@amc-systeme.de Web: www.amc-systeme.de

I/O view

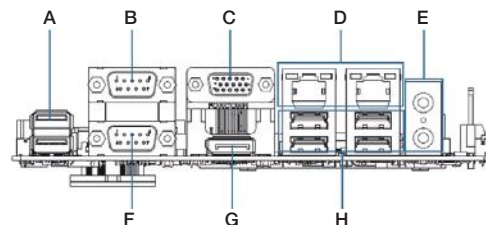

- | | |
|-------------------------|--------------------|
| A. USB3.1 | E. Line-out/Mic-in |
| B. RS232 | F. RS232/422/485 |
| C. VGA | G. Display Port |
| D. 2 x Gigabit Ethernet | H. USB 3.1 |